

Shotgun Nomenclature Chart

You do not need to know the gun parts at this time.

Pump Action Shotgun

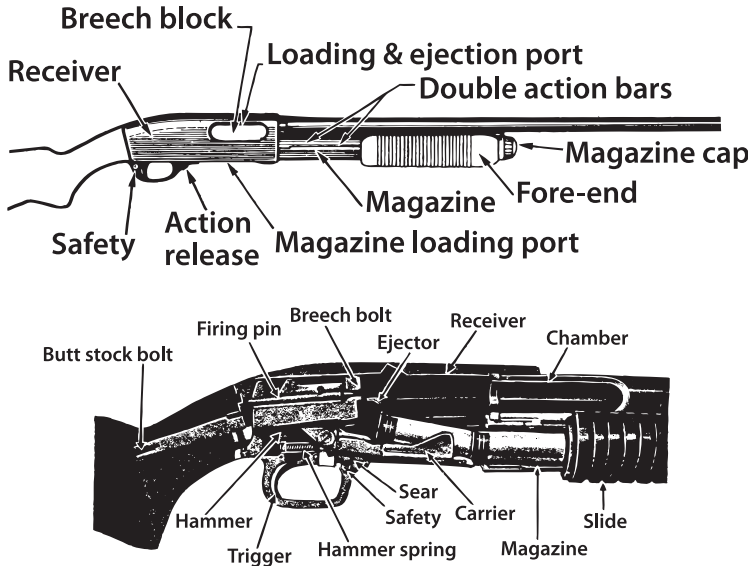

Break Action Shotgun

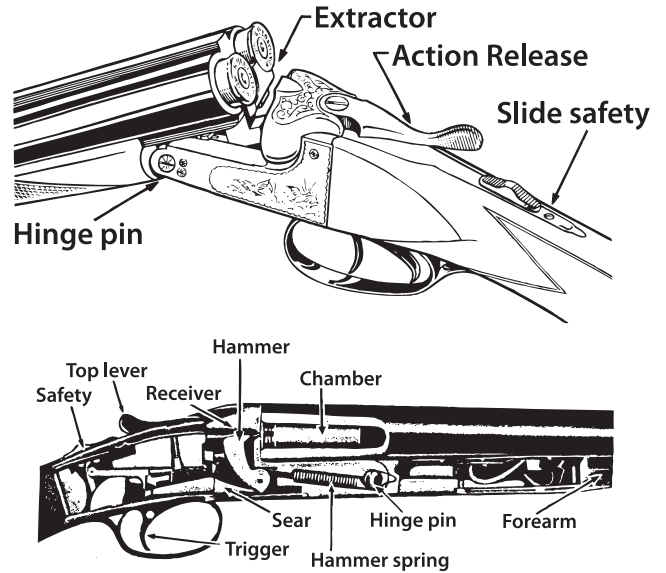

Semi-Automatic Shotgun

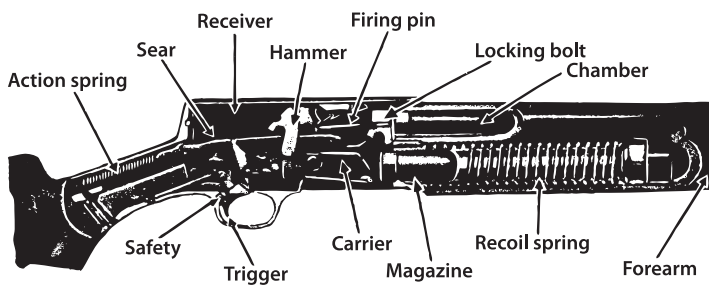

Shotgun Shell

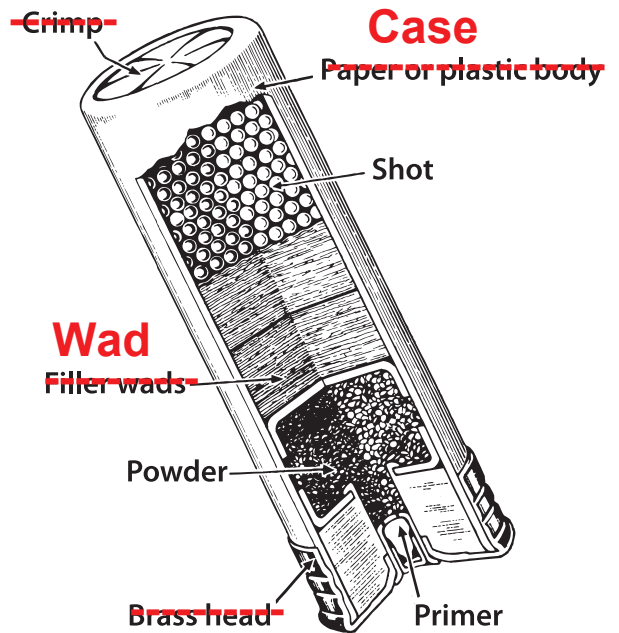

Shotgun Rifled Slug

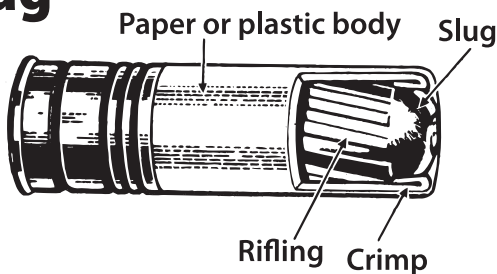

Know Your Gun and Ammo

Shotgun and Rifle Barrel Differences

smooth

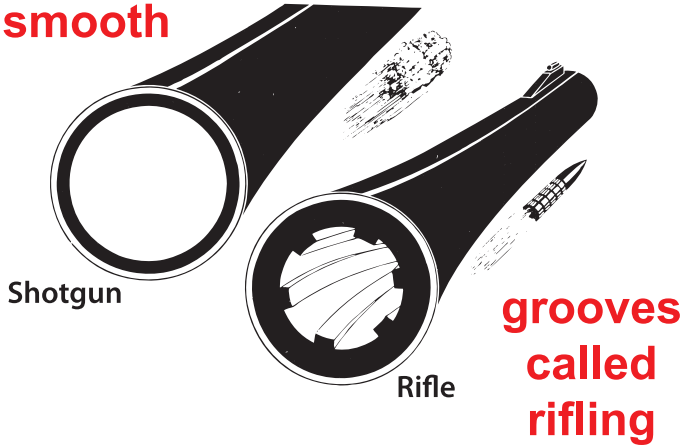

Varieties of Shotgun Chokes

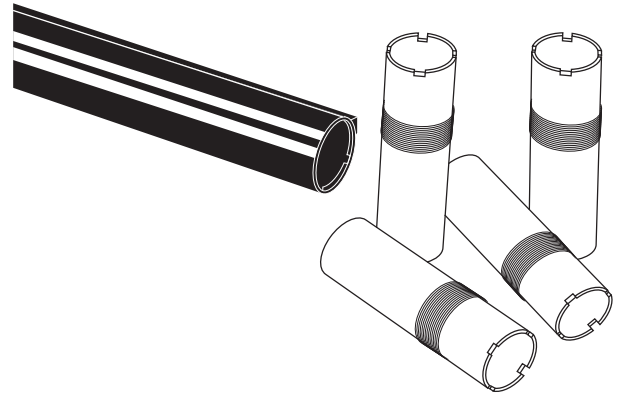

Choke Shot Patterns

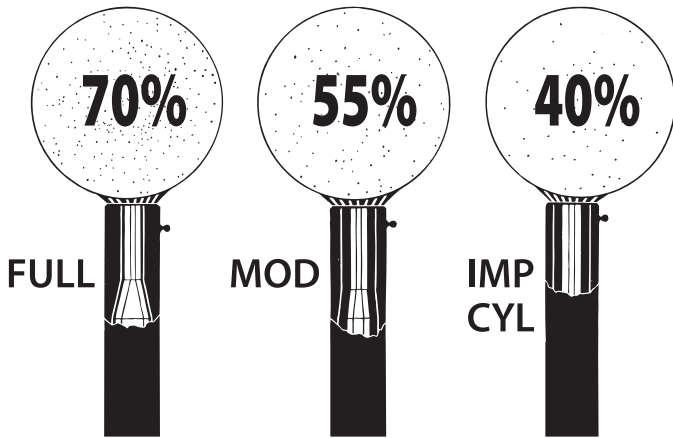

Types of Twist Steel Barrels



Damascus Barrel

Popular Shotgun Shell Gages

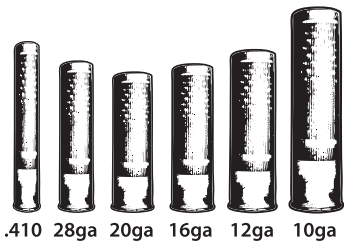

Use of incorrect ammo will cause barrel obstruction and dangerous conditions



Sizes of Shot

- Bird shot /Size 12
- No. 9
- No. 8
- No. 7 1/2
- No. 6
- No. 5
- No. 4
- No. 2
- BB
- No. 4 Buck
- No. 3 Buck
- No. 1 Buck
- No. 0 Buck
- No. 00 Buck
- No. 000 Buck

Notice how a smaller shell can slide down the barrel.



Rifle Nomenclature Chart

You do not need to know the gun parts at this time.

Bolt Action Rifle

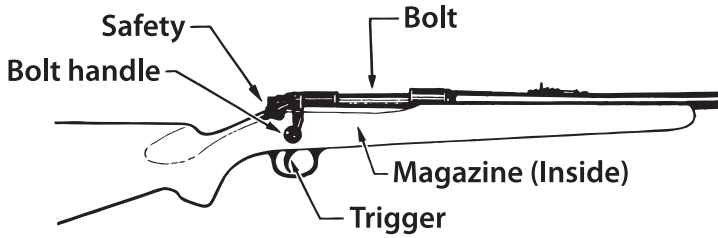

Semi-Automaic Rifle

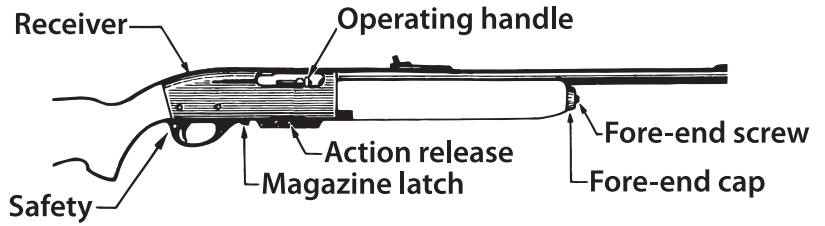

Break Action Rifle

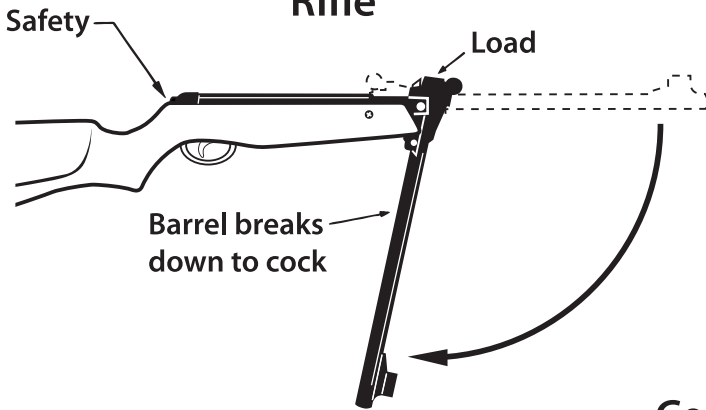

Lever Action Rifle

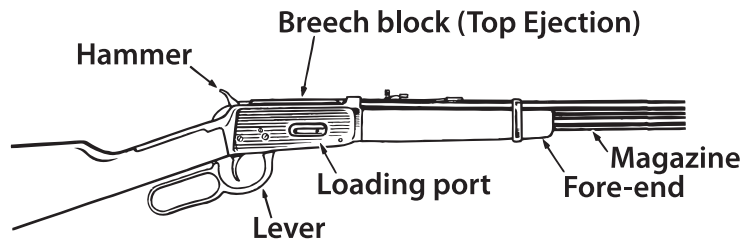

Rim-Fire Cartridge

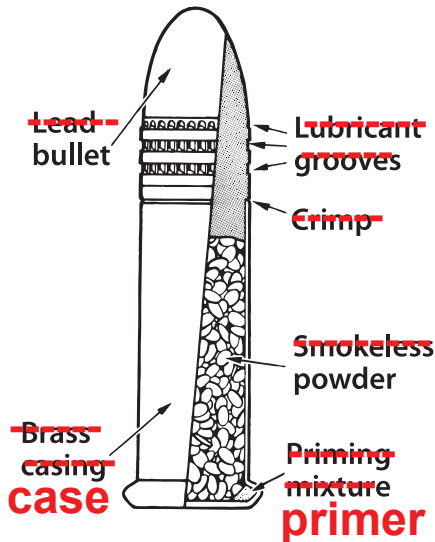

Center-Fire Cartridge

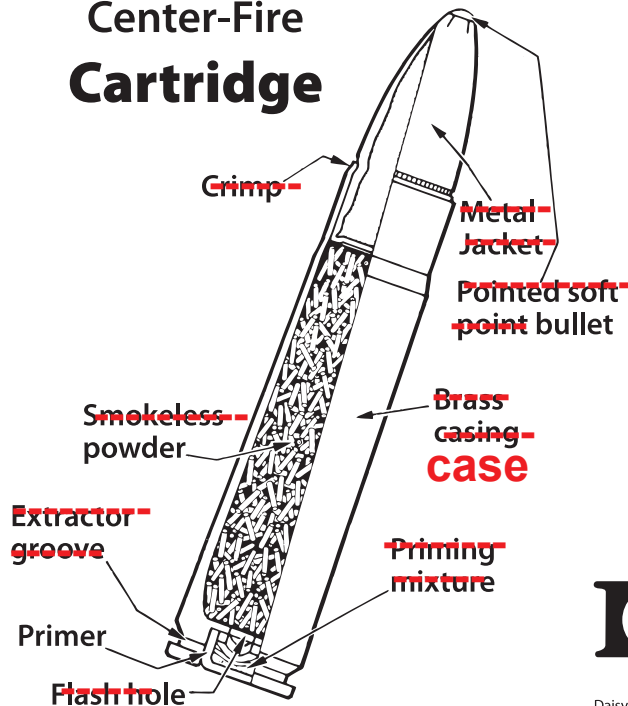

The 4 parts you need to know are:

- * case
- * powder
- * bullet
- * primer

